

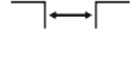

Loads up to 600 kN



Top mounted



Joint width 150-500 mm



Movements in 3 planes



Indoor/  
outdoor<sup>2</sup>

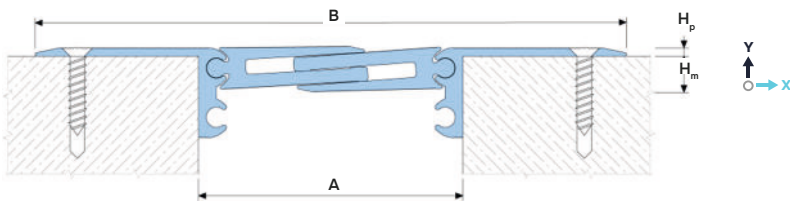

**DESIGNATIONS:**

A – nominal joint width;  
B – visible width;  
H<sub>p</sub> – profile height;

H<sub>m</sub> – installation depth;  
M<sub>x</sub> – horizontal movements;  
M<sub>y</sub> – vertical movements;

| Profile   | Sizes, mm |     |                |                | Movements, mm  |                | Permissible loads <sup>1</sup> (kN) |     |     |    |
|-----------|-----------|-----|----------------|----------------|----------------|----------------|-------------------------------------|-----|-----|----|
|           | A         | B   | H <sub>p</sub> | H <sub>m</sub> | M <sub>x</sub> | M <sub>y</sub> |                                     |     |     |    |
| SV 46/155 | 155       | 350 | 5              | 48             | 54 (±27)       | 60 (±30)       | 50                                  | 600 | 140 | 20 |
| SV 46/180 | 180       | 375 | 5              | 48             | 70 (±35)       | 70 (±35)       | 50                                  | 600 | 140 | 20 |
| SV 46/210 | 210       | 405 | 5              | 48             | 80 (±40)       | 80 (±40)       | 50                                  | 600 | 140 | 20 |
| SV 46/230 | 230       | 425 | 5              | 48             | 60 (±30)       | 60 (±30)       | 50                                  | 300 | 90  | 10 |
| SV 46/250 | 250       | 445 | 5              | 48             | 60 (±30)       | 60 (±30)       | 50                                  | 300 | 90  | 10 |
| SV 46/300 | 300       | 495 | 5              | 48             | 70 (±35)       | 70 (±35)       | 50                                  | 300 | 90  | 10 |
| SV 46/350 | 350       | 545 | 5              | 48             | 80 (±40)       | 90 (±45)       | 50                                  | 100 | 70  | 5  |
| SV 46/400 | 400       | 595 | 5              | 48             | 100 (±50)      | 100 (±50)      | 50                                  | 100 | 50  | 5  |
| SV 46/500 | 500       | 695 | 5              | 48             | 100 (±50)      | 100 (±50)      | 50                                  | 100 | 30  | 5  |

<sup>1</sup>The profile is suitable for parking lots and similar buildings and is not intended for open areas with free movement of vehicles at speeds exceeding 10 km/h.

<sup>2</sup>It is not recommended to use the profile under the open rays of the sun and with possible large temperature fluctuations due to the large difference in the coefficients of thermal expansion of concrete and aluminum.

**▶ TECHNICAL DATA**

→ **FRAME AND INSERT**

|                      |  |
|----------------------|--|
| <b>Material</b>      | Aluminum EN AW 6063 T6 (T66 <sup>3</sup> ) |
| <b>Strength, MPa</b> | σ <sub>s</sub> =205 (255 <sup>3</sup> )    |
| <b>Tolerances</b>    | EN 12020-2:2008                            |
| <b>Tooling</b>       | Mounting holes                             |
| <b>Fasteners</b>     | Included (Screws Rawlplug)                 |
| <b>Surface coat</b>  | Mill finish <sup>4</sup>                   |
| <b>Length, m</b>     | 3,0  |

<sup>3</sup>For EU market.

<sup>4</sup>The profile can be optionally anodized (ask for details).

**▶ EQUIPMENT PROFILE**

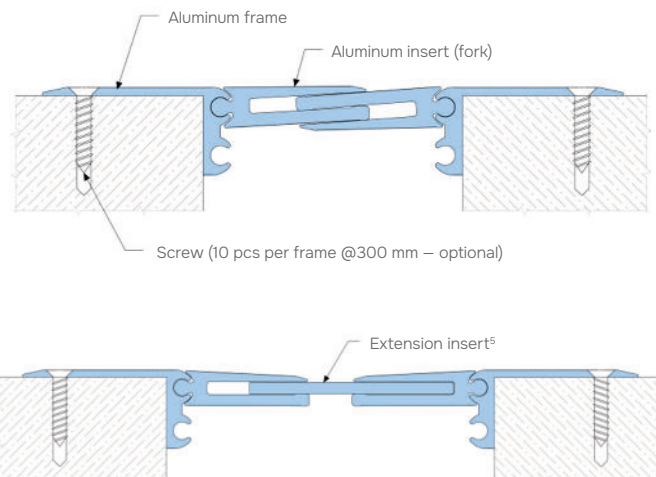

<sup>5</sup> Profiles for a joint width of 230 mm are completed with an extension insert:  
- SV 46/230, SV 46/250, SV 46/300, SV 46/350, SV 46/400, SV 46/500,

### ▶ LABELING

(example)

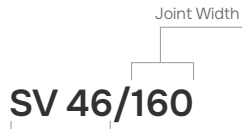

Profile Series:  
 SV 46 – standard version  
 SV-E 46 – marked if required – see “Corner version”

### ▶ CORNER VERSION

Profiles have corner versions for Floor-to-wall connections (joint along the wall). These profiles have an index "E": SV-E.

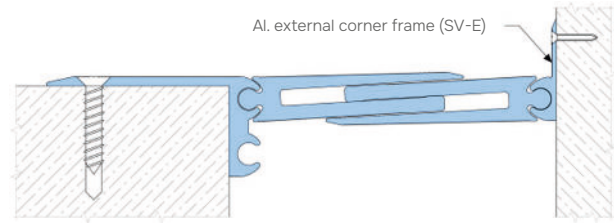

Example: SV-E 46/160

### ▶ EXECUTION OPTIONS



Using a moisture barrier for waterproofing an expansion joint.

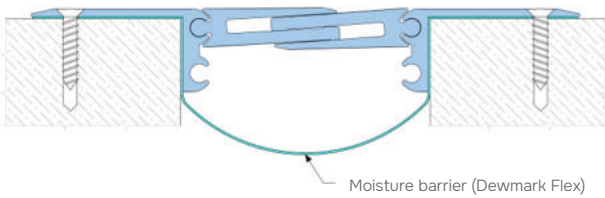

Use of a fire barrier with a fire resistance rating of up to EI 240.

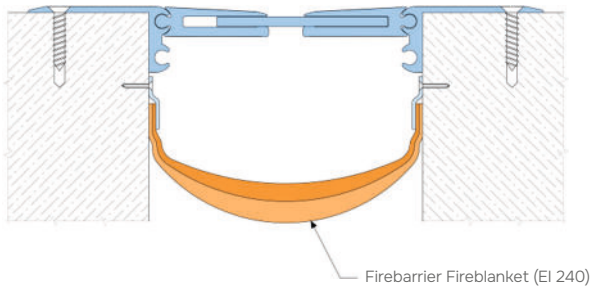

Different height version of the profile.

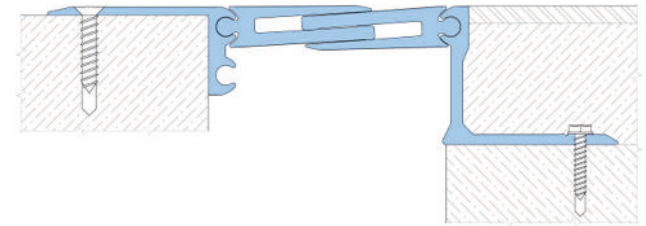

Example: SV 45-46/135-155/80